

# IES Photometric files E300

## Isoline template 7' mounting height

Isoline values — 0.1 fc — 0.25 fc — 0.5 fc — 1.0 fc — 2.0 fc

Mounting height 7' Tilt 0°

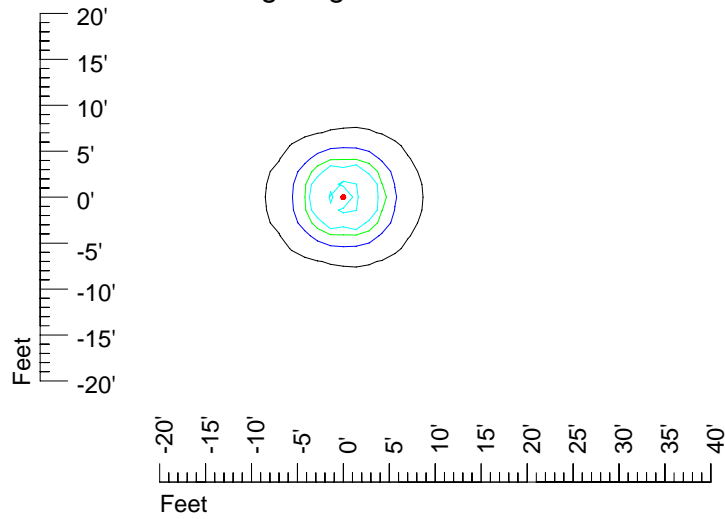

Mounting height 7' Tilt 30°

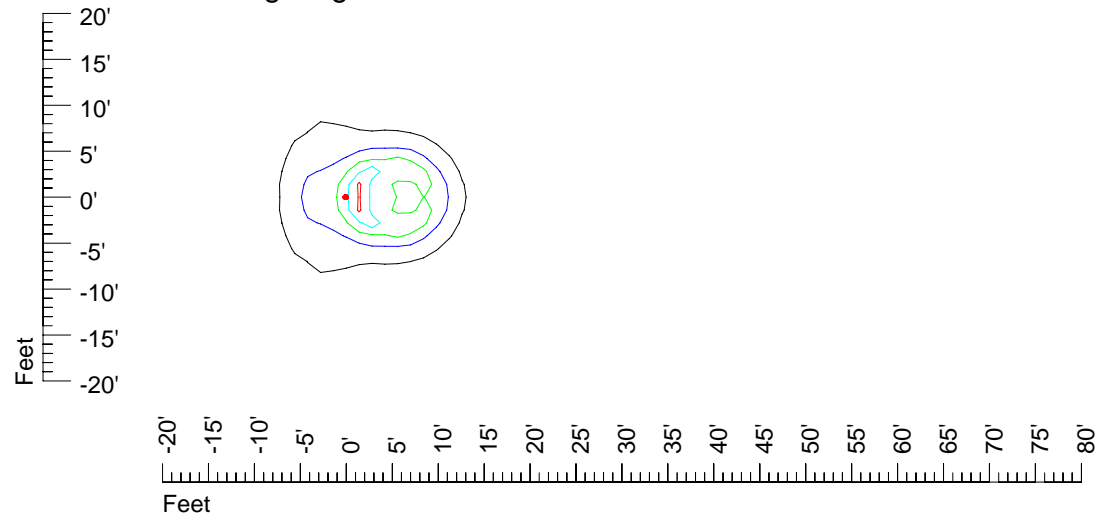

Mounting height 7' Tilt 15°

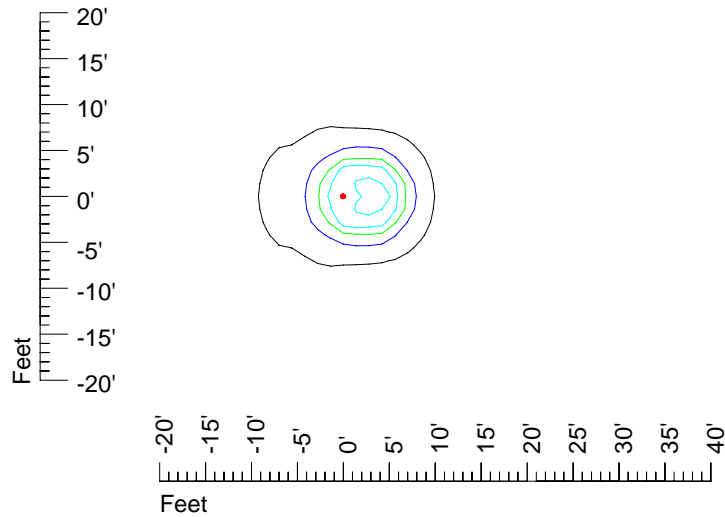

Mounting height 7' Tilt 45°

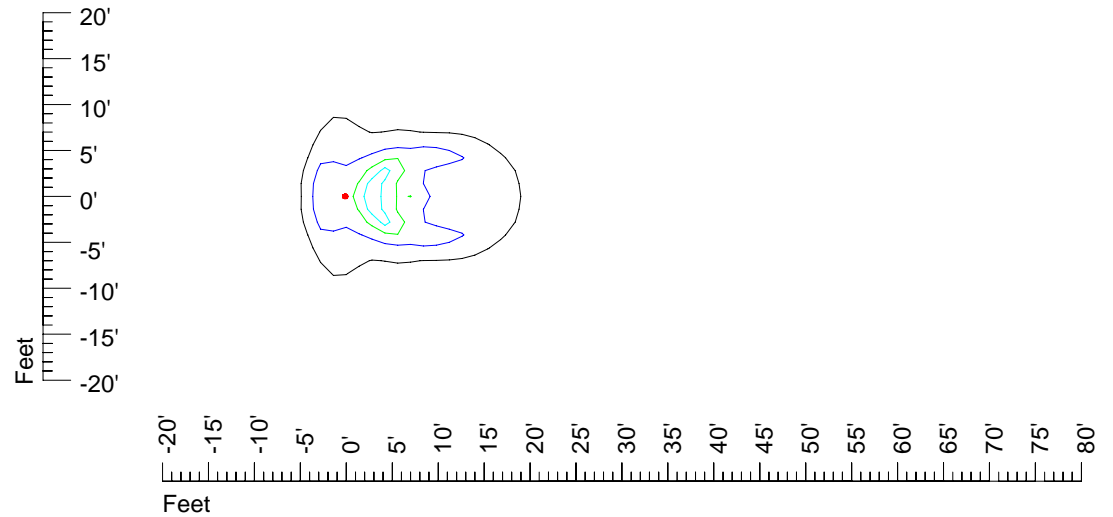

# IES Photometric files E300

## Isoline template 9' mounting height

Isoline values — 0.1 fc — 0.25 fc — 0.5 fc — 1.0 fc — 2.0 fc

Mounting height 9' Tilt 0°

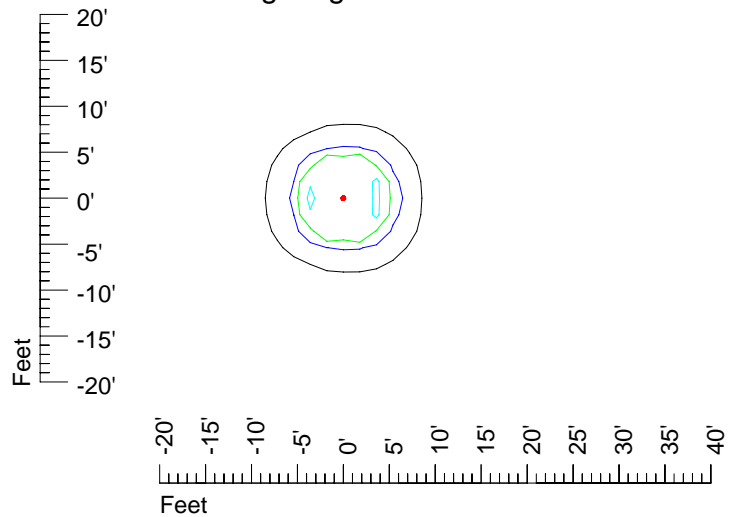

Mounting height 9' Tilt 30°

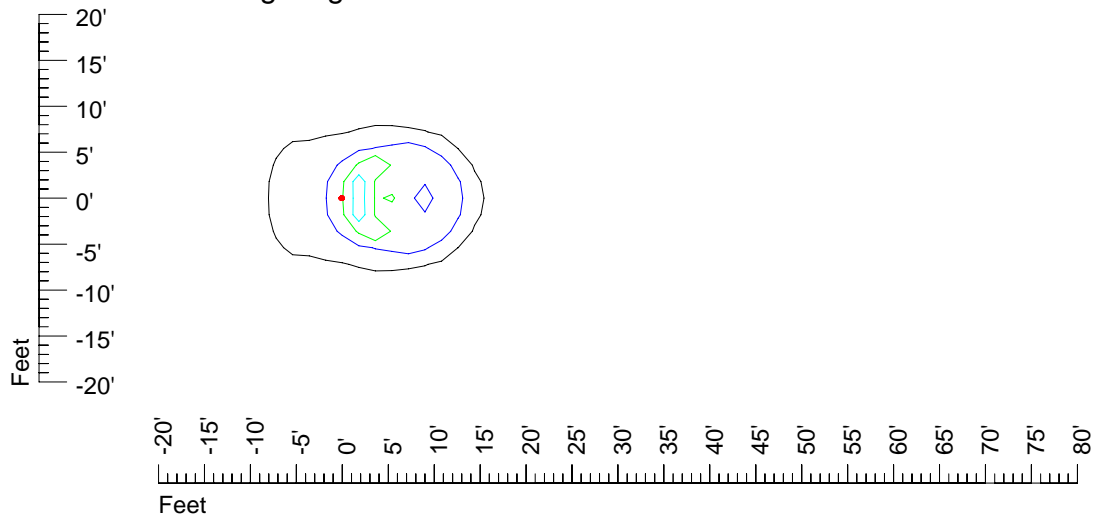

Mounting height 9' Tilt 15°

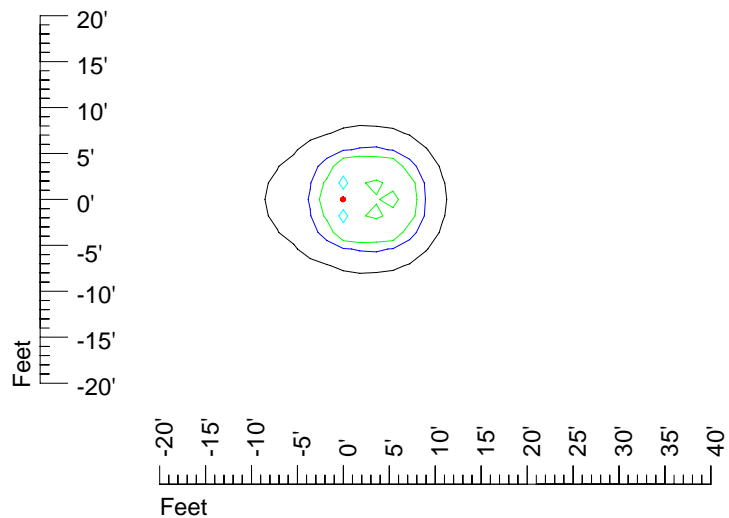

Mounting height 9' Tilt 45°

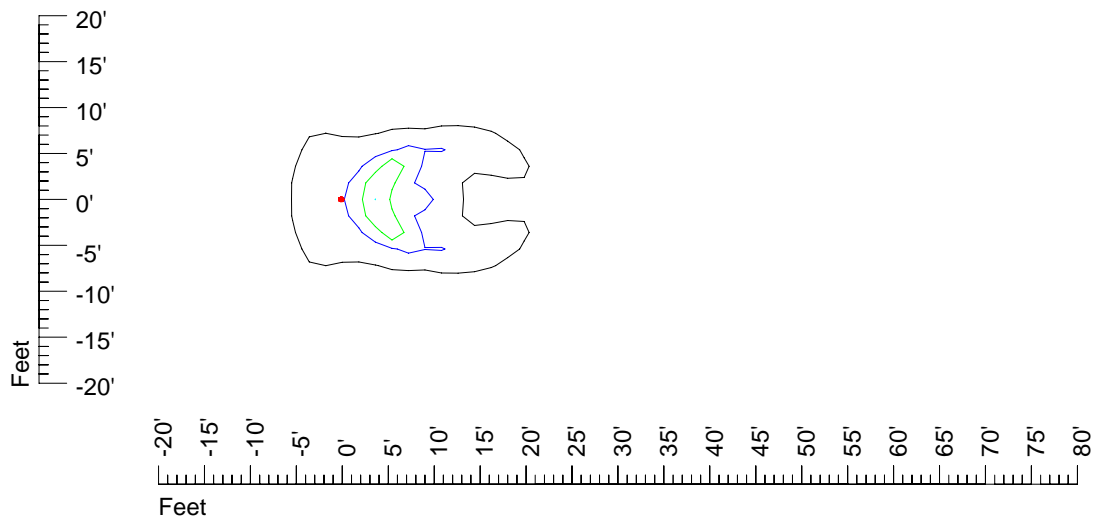

# IES Photometric files E300

## Isoline template 11' mounting height

Isoline values — 0.1 fc — 0.25 fc — 0.5 fc — 1.0 fc — 2.0 fc

Mounting height 11' Tilt 0°

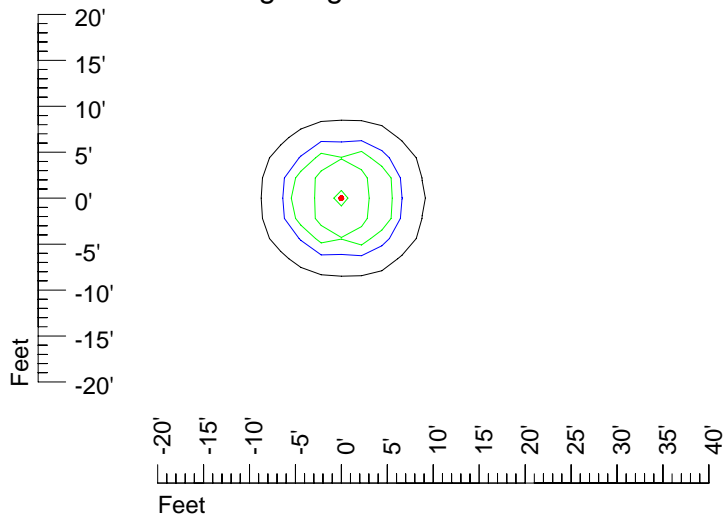

Mounting height 11' Tilt 30°

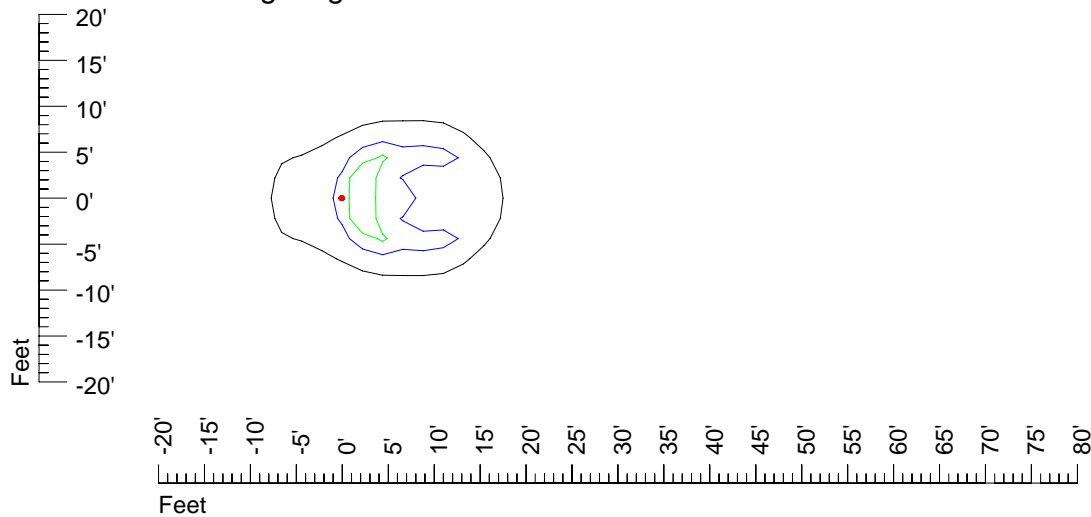

Mounting height 11' Tilt 15°

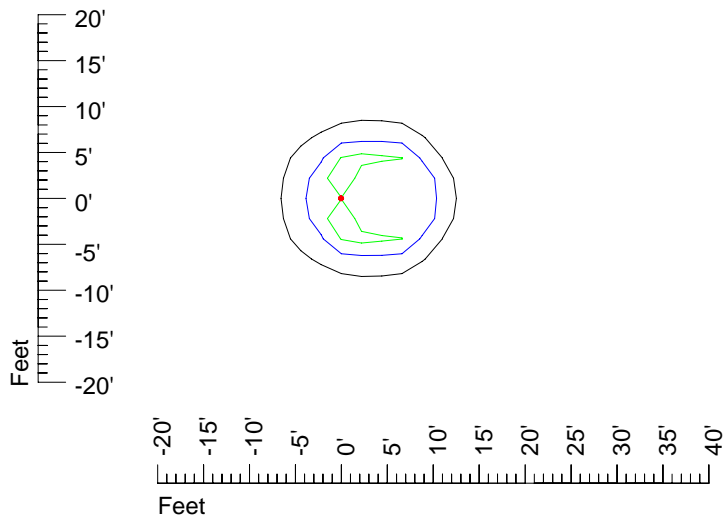

Mounting height 11' Tilt 45°

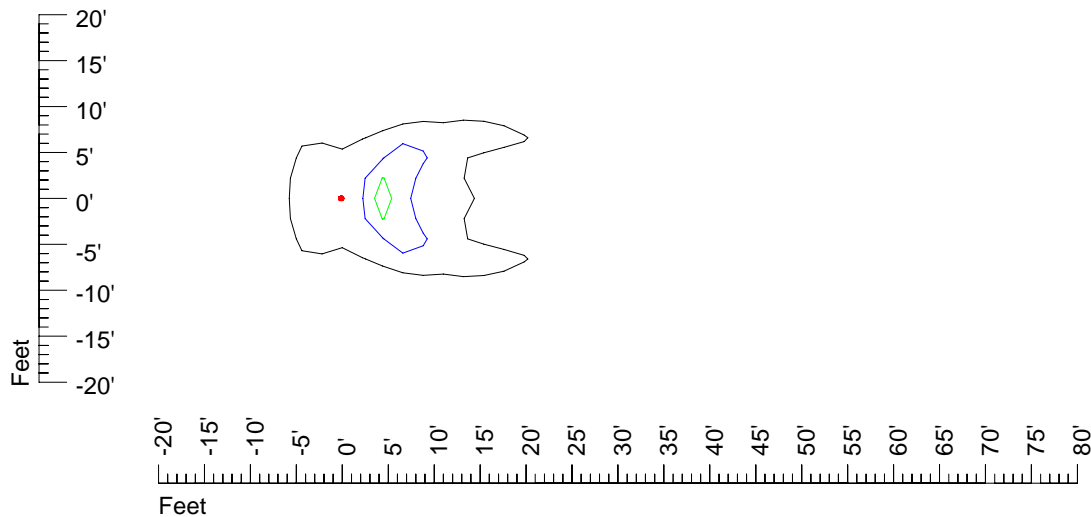

# IES Photometric files E300

## Isoline template 15' mounting height

Isoline values — 0.1 fc — 0.25 fc — 0.5 fc — 1.0 fc — 2.0 fc

Mounting height 15' Tilt 0°

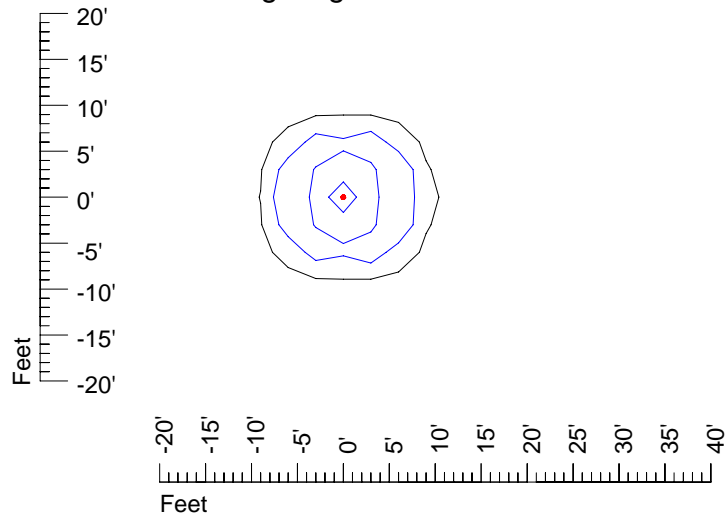

Mounting height 15' Tilt 30°

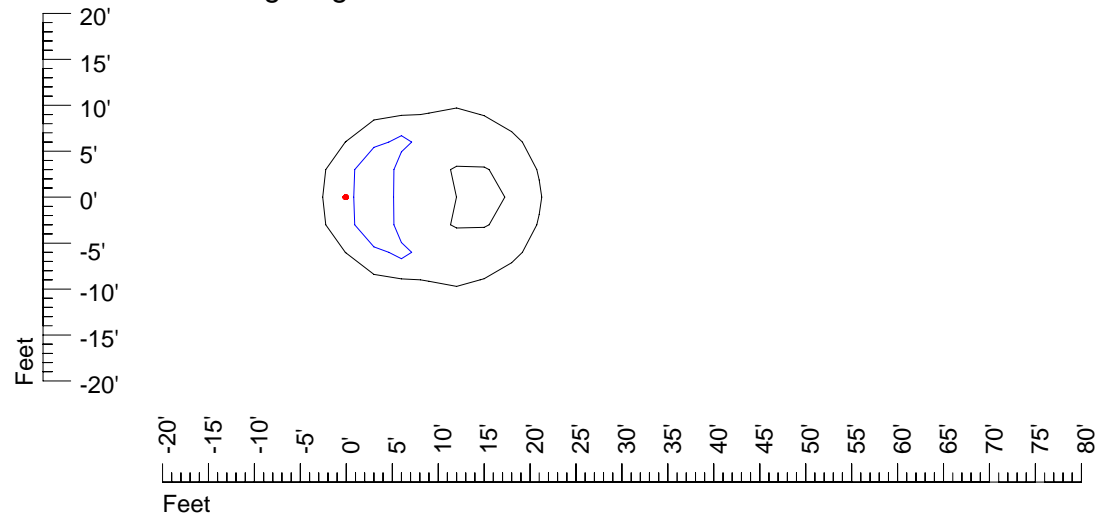

Mounting height 15' Tilt 15°

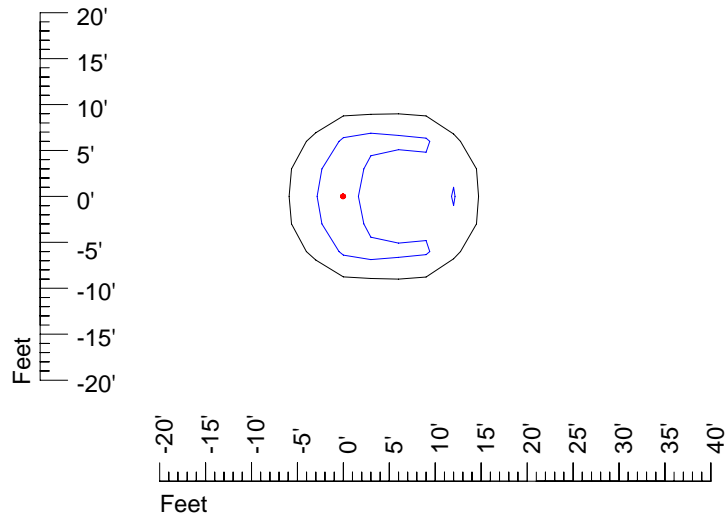

Mounting height 15' Tilt 45°

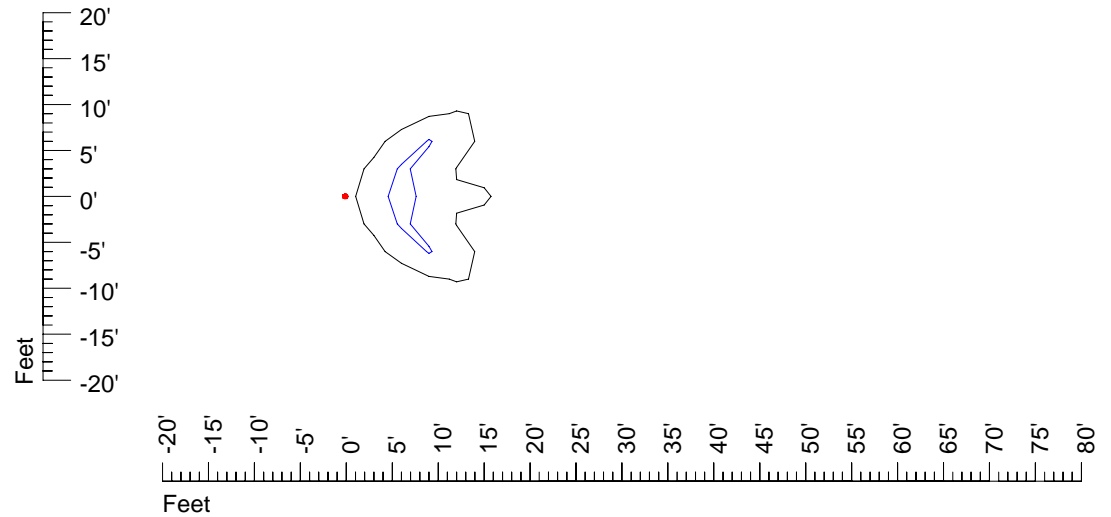

# IES Photometric files E300

## Isoline template 20' mounting height

Isoline values — 0.1 fc — 0.25 fc — 0.5 fc — 1.0 fc — 2.0 fc

Mounting height 20' Tilt 0°

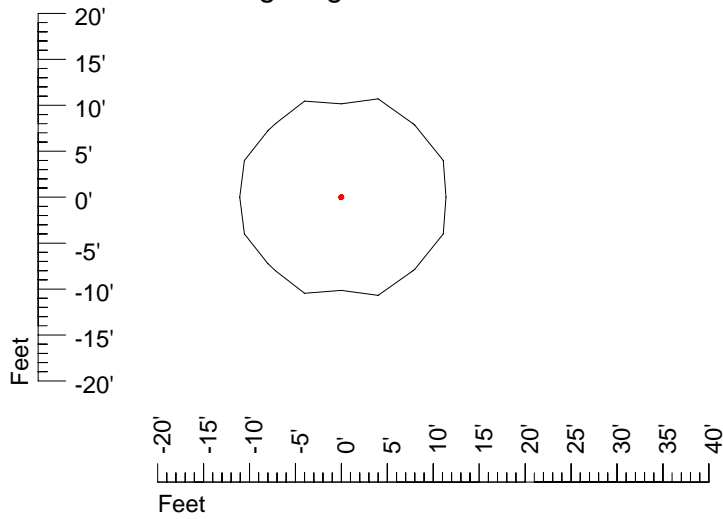

Mounting height 20' Tilt 30°

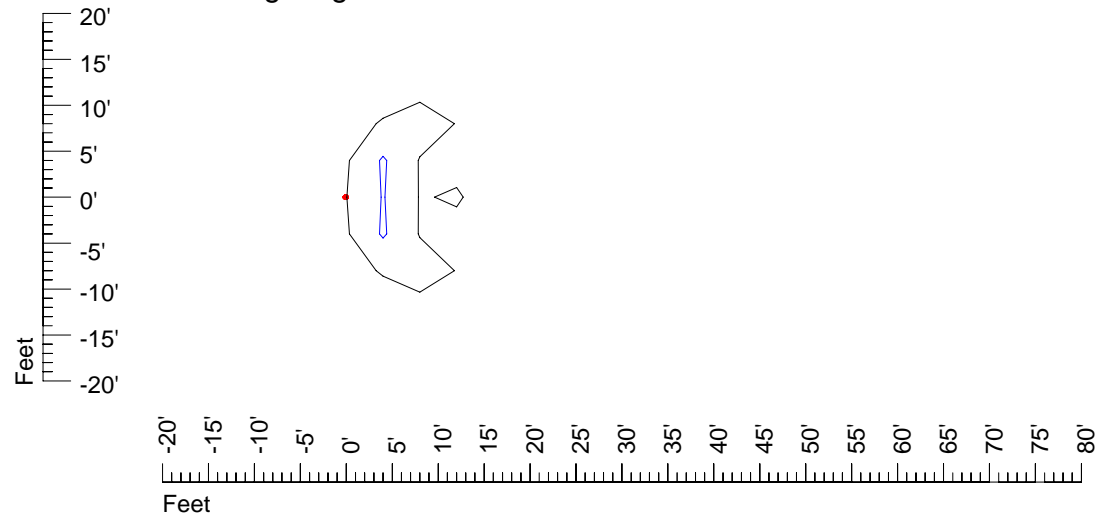

Mounting height 20' Tilt 15°

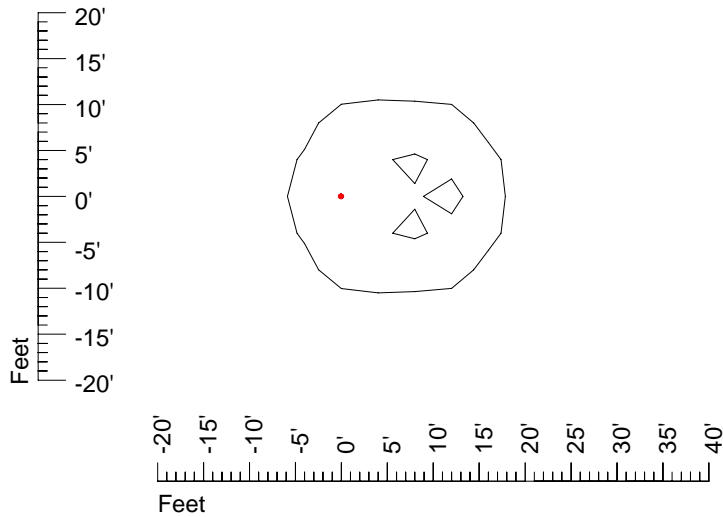

Mounting height 20' Tilt 45°

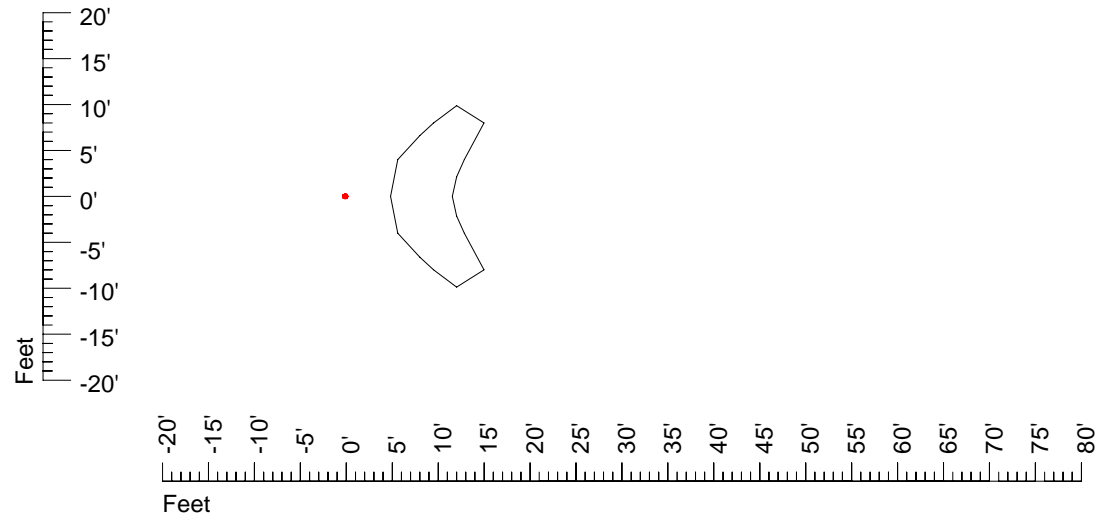

# IES Photometric files E300

## Isoline template 25' mounting height

Isoline values — 0.1 fc — 0.25 fc — 0.5 fc — 1.0 fc — 2.0 fc

Mounting height 25' Tilt 0°

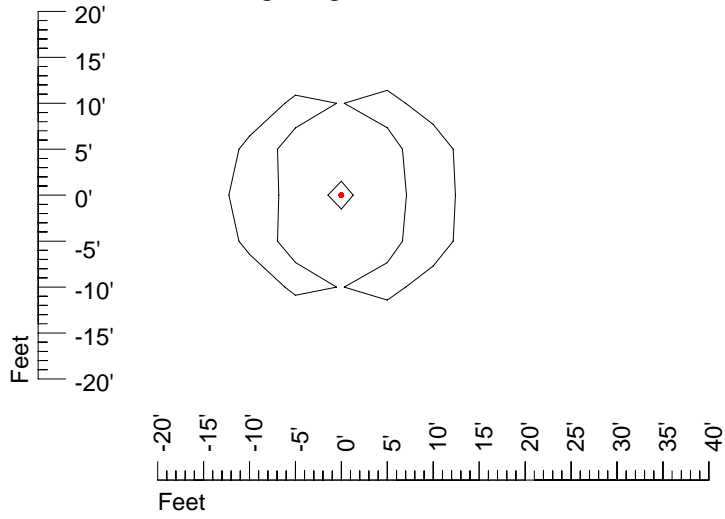

Mounting height 25' Tilt 30°

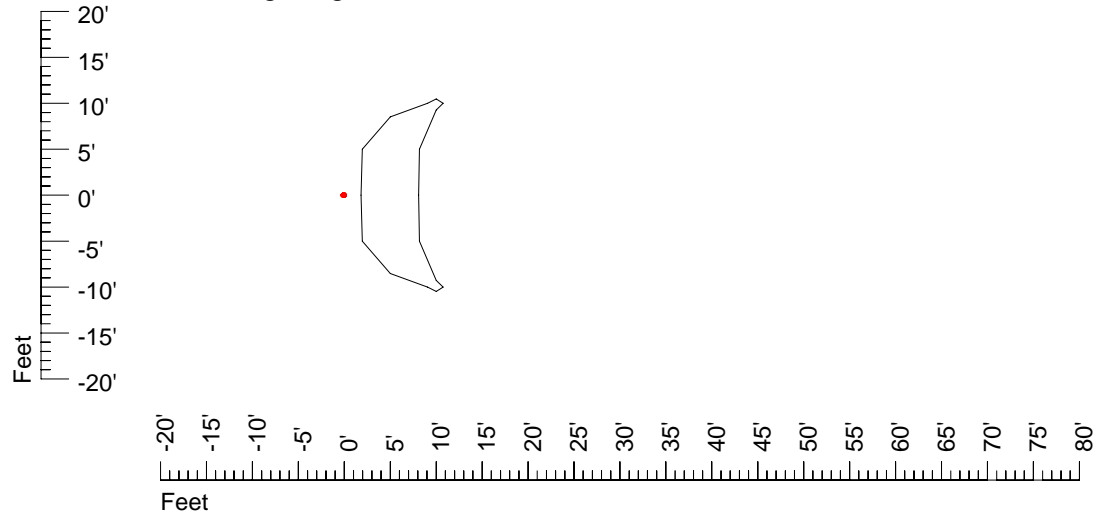

Mounting height 25' Tilt 15°

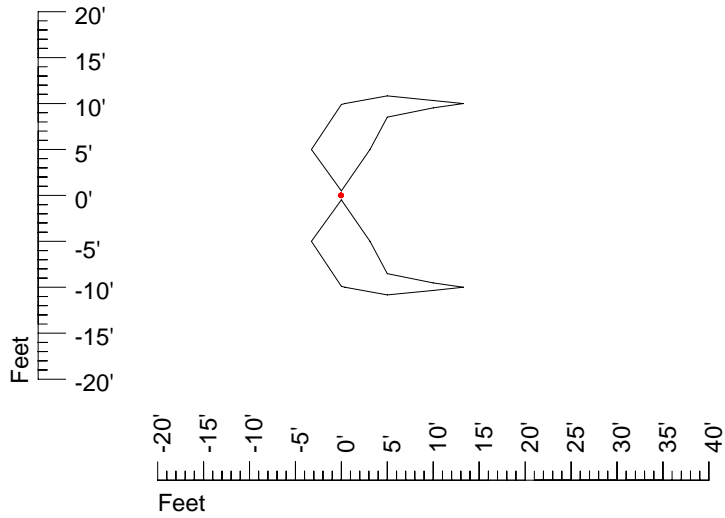

Mounting height 25' Tilt 45°

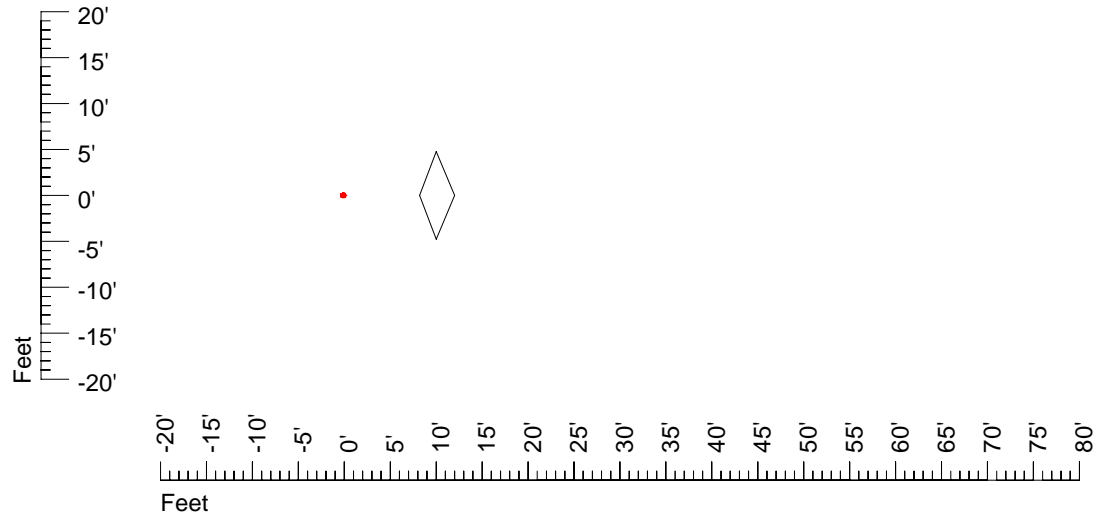

# IES Photometric files E300

## Isoline template 30' mounting height

Isoline values — 0.1 fc — 0.25 fc — 0.5 fc — 1.0 fc — 2.0 fc

