

## EXC LED Series

Class I, Division 1 & 2, Group C & D; Class II, Division 1 & 2, Group E, F & G; Class III remote fixture for hazardous locations



### Housing

- One-piece heavy gauge, corrosion resistant, copper-free cast aluminum
- Consists of a housing with provisions for up to two lighting heads
- Spin-off gasketed cover prevents propagation of internally generated arcs
- Stainless steel vent/drain
- Lighting head fixtures are heavy cast aluminum with Pyrex® lens
- Exit faceplate: heavy-duty 20 gauge steel, baked enamel gray finish
- 6 inch EXIT lettering legend, available in red or green
- Field-selectable chevrons

### Mounting

- Surface wall mount
- 3/4" NPT conduit entry on top and bottom of housing
- Single and double pendant mount heads include elbow swivel, conduit extension pipe (6" increments)

### Electronics

- Pulse plus charger
- Low voltage disconnect
- Automatic brownout protection
- Battery lock-out
- Fused output circuit
- 120/277 60Hz

### Lamp type

- Heads offer a choice of MR16 LED lamp wattages
- Exit sign uses a 3 watt LED lamp

### Battery type

- 6V or 12V, nickel-cadmium battery

### Approvals

- CSA-US (to UL 924 standards)
- Manufactured in accordance with UL844, UL1203
- Class I, Division 1 & 2, Groups C & D
- Class II, Division 1 & 2, Groups E, F & G
- Class III
- NEC, OSHA and NEMA compliant for above Classes and Groups
- Temperature code T6

### Warranty

- Unit has five-year warranty
- Detailed warranty terms located on **page 178** or online at: [www.emergi-lite.com/usa/files/EL\\_Warranty.pdf](http://www.emergi-lite.com/usa/files/EL_Warranty.pdf)



### Photometric performance

Lamp	Spacing center-to-center (feet)	
	7' mounting height	15' mounting height
2 x LA	43'	29'
2 x LG	55'	36'
2 x LI	67'	41'
2 x LJ	87'	62'

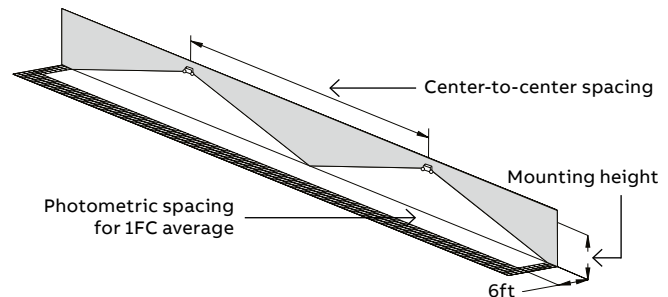

### Dimensions

Dimensions are approximate and subject to change.

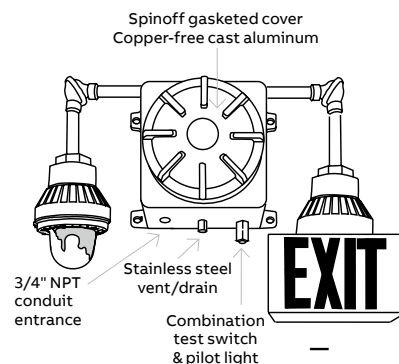

### Housing:

12" X 12" X 9 1/2"  
 (4) Mounting Lugs:  
 10" and 13- 1/2" on center

**Overall dimensions**  
 (including fixtures):  
 38" X 38" X 10"

Standard configurations for EXC Series

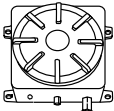
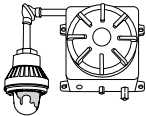
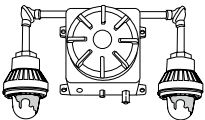
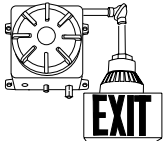
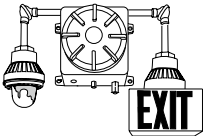
Unit	Catalog number examples	Description
	6EXC1	6 volt self contained hazardous location emergency battery unit 18 watts of remote capacity.
(Remote capability)	6EXC1-TS	6 volt self contained hazardous location emergency battery unit 18 watts of remote capacity. Transfer switch included for use with remote exit signs (maximum 5 exit signs per TS).
	12EXC4-1LI	12 volt self contained hazardous location emergency battery unit with one head containing 2 X 12V 5W MR16 LED lamps, 30 watts of remote capacity.
	12EXC4-1LI-TS	12 volt self contained hazardous location emergency battery unit with one head containing 2 X 12V 5W MR16 LED lamps, 30 watts of remote capacity. Transfer switch included for use with remote exit signs (maximum 5 exit signs per TS).
	6EXC3-2LA	6 volt self contained hazardous location emergency battery unit with two heads, each containing 2 X 6V 4W MR16 LED lamps, 14 watts of remote.
	6EXC3-2LA-TS	6 volt self contained hazardous location emergency battery unit with two heads, each containing 2 X 6V 4W MR16 LED lamps, 14 watts of remote capacity. Transfer switch included for use with remote exit signs (maximum 5 exit signs per TS).
	6EXC1-TS-T1LR	6 volt self contained exit sign with 15 watts of remote capacity. Transfer switch included for use with integral exit sign and additional remote exit signs (maximum 5 exit signs per TS).
	12EXC4-1LJ-TS-T1LR	12 volt self contained combination unit with 25 watts of remote capacity. Transfer switch included for use with integral exit sign and additional remote exit signs (maximum 5 exit signs per TS).

Note: Exit signs utilise a 3 watt bayonet base LED bulb fabricated at our North American facility.

Unit rating – equipment with remote capability

Sealed maintenance-free battery type	D.C. voltage	Model number	Battery capacity in watts			
			1-1/2 hrs	2 hrs	4 hrs	8 hrs
Nickel-cadmium	6	EXC1	8	12	9	6
	6	EXC3	30	20	15	10
	12	EXC2	24	18	12	9
	12	EXC4	40	30	20	15

How to order

Series / capacity	# of heads and lamps	Lamp wattage/type	Battery unit option
6EXC1= 6Vdc battery unit/combo 18W (6V only)	-0= No emergency head	LA= 6V 4W MR16 LED	Blank= No transfer panel
6EXC3= 6Vdc battery unit/combo 30W (6V only)	-1= Single head,	LG= 12V 4W MR16 LED	-TS= Transfer panel
12EXC2= 12Vdc battery unit/combo 24W (12V only)	two lamps	LI= 12V 5W MR16 LED	(required to supply
12EXC4= 12Vdc battery unit/combo 40W (12V only)	-2= Two heads, two lamps each	LJ= 12V 6W MR16 LED	remote exit sign only)

Exit sign # of faces	Exit sign lamp	Exit sign letter color
Blank= No exit sign	L= LED exit sign	Blank= No exit sign
-T1= Single face exit sign		R= Red
		G= Green

Example: 12EXC4-1LJ-TS-T1LRR