

IES Photometric files C9277

Isoline template at 7' mounting height

Isoline values — 0.1 fc — 0.25 fc — 0.5 fc — 1.0 fc — 2.0 fc

Mounting height 7' Tilt 0°

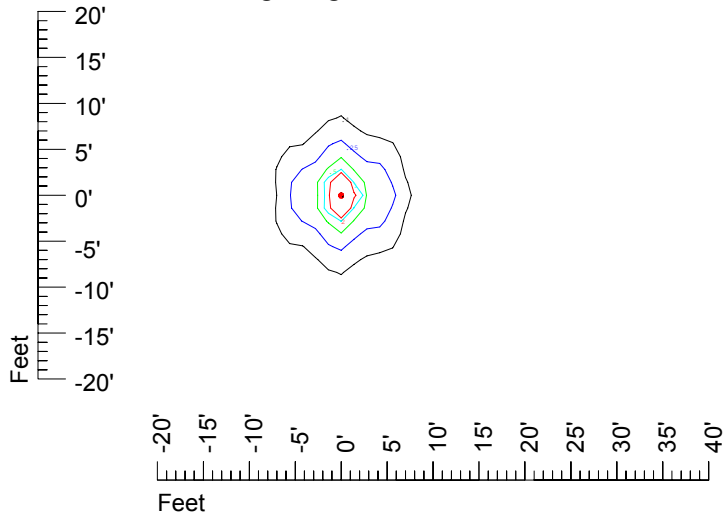

Mounting height 7' Tilt 30°

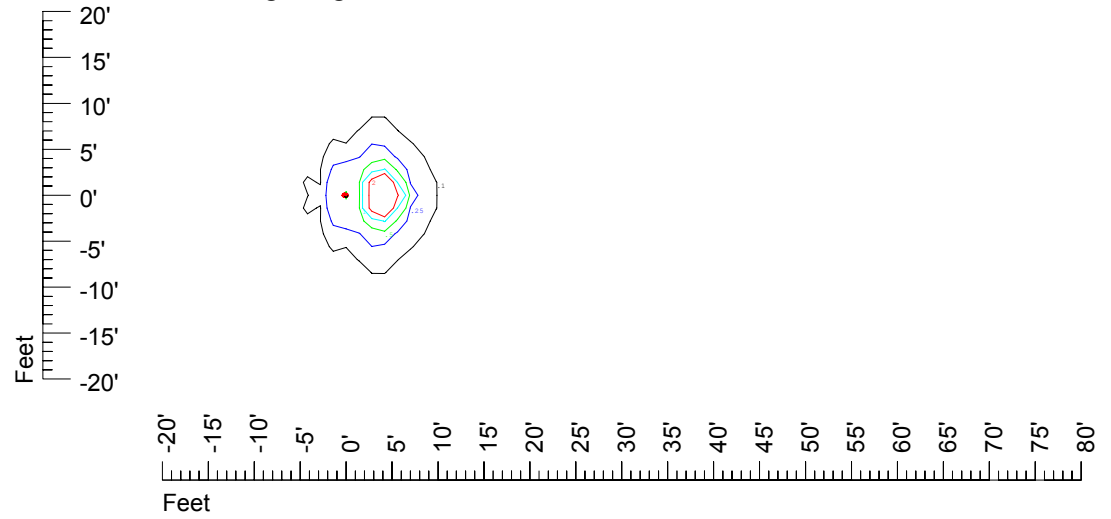

Mounting height 7' Tilt 15°

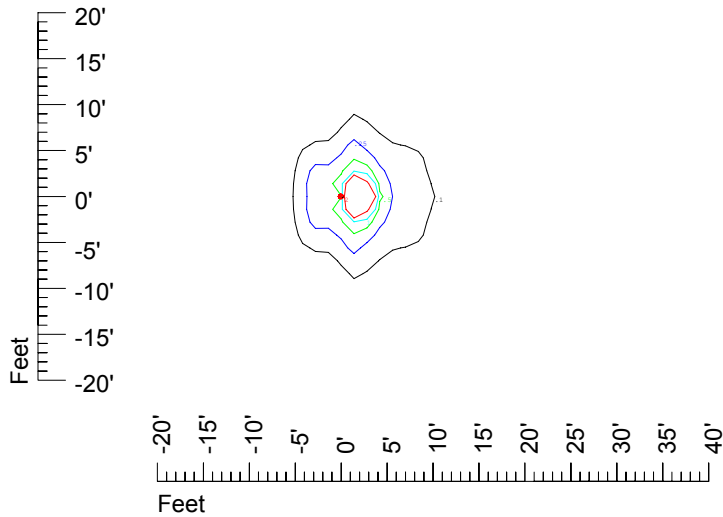

Mounting height 7' Tilt 45°

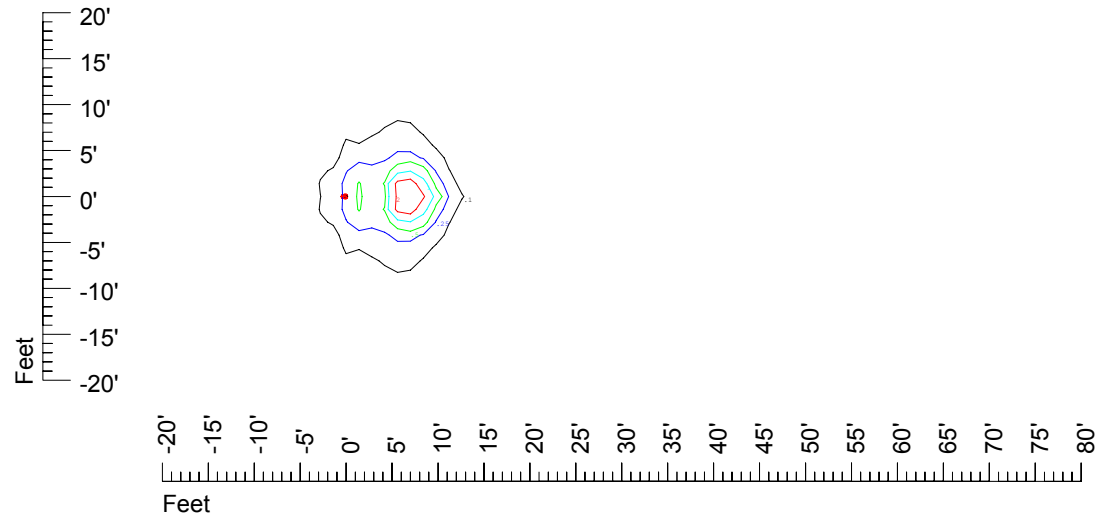

IES Photometric files C9277

Isoline template at 9' mounting height

Isoline values — 0.1 fc — 0.25 fc — 0.5 fc — 1.0 fc — 2.0 fc

Mounting height 9' Tilt 0°

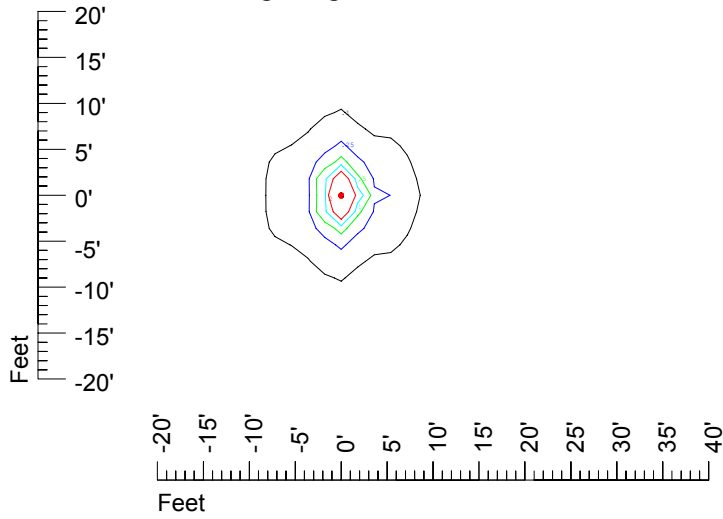

Mounting height 9' Tilt 30°

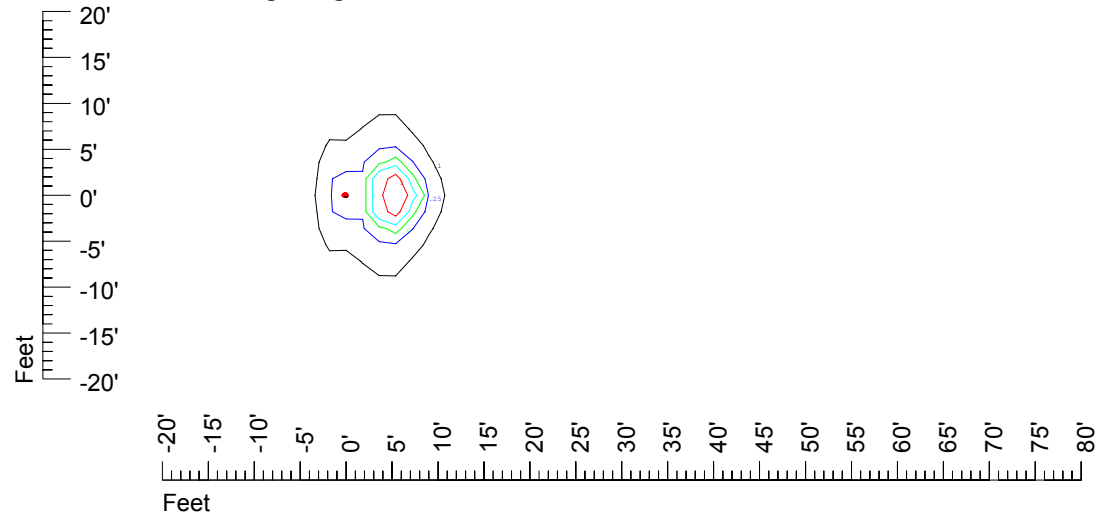

Mounting height 9' Tilt 15°

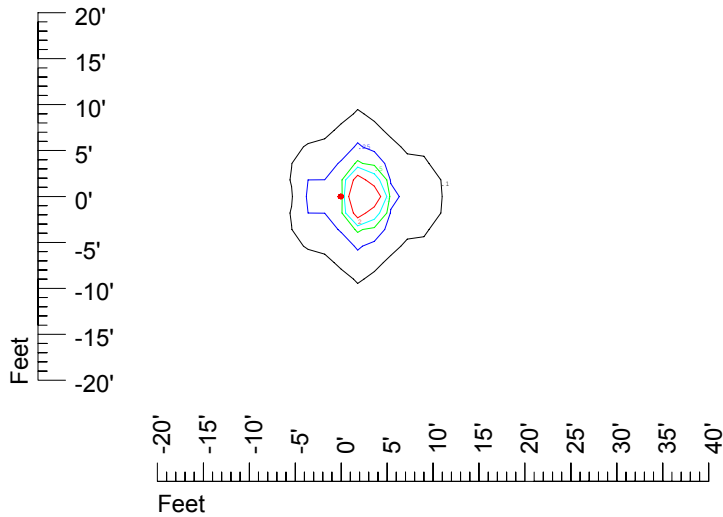

Mounting height 9' Tilt 45°

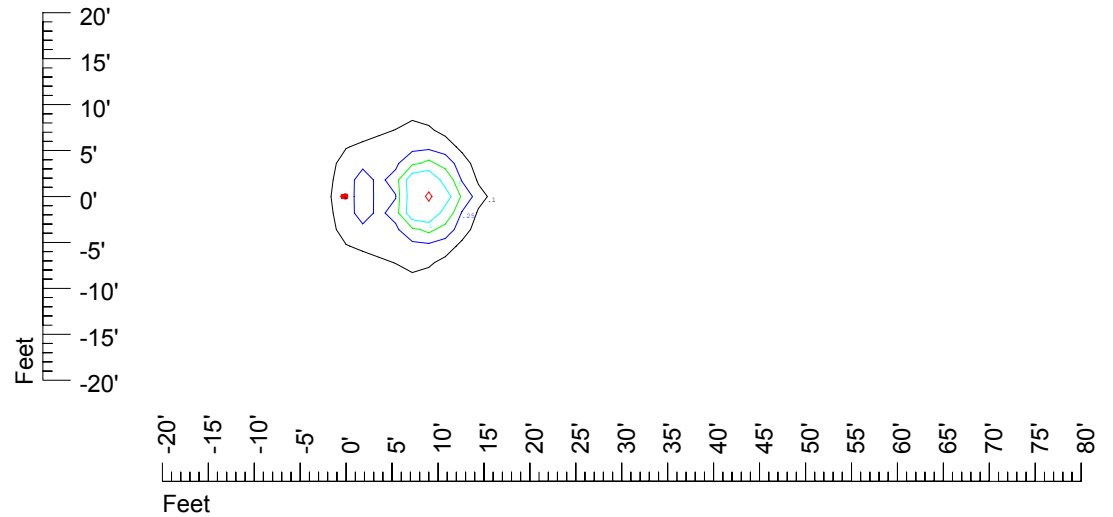

IES Photometric files C9277

Isoline template at 11' mounting height

Isoline values — 0.1 fc — 0.25 fc — 0.5 fc — 1.0 fc — 2.0 fc

Mounting height 11' Tilt 0°

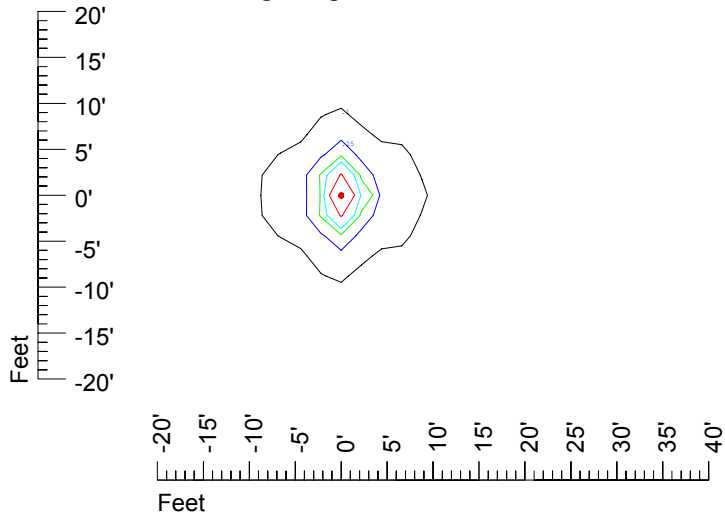

Mounting height 11' Tilt 30°

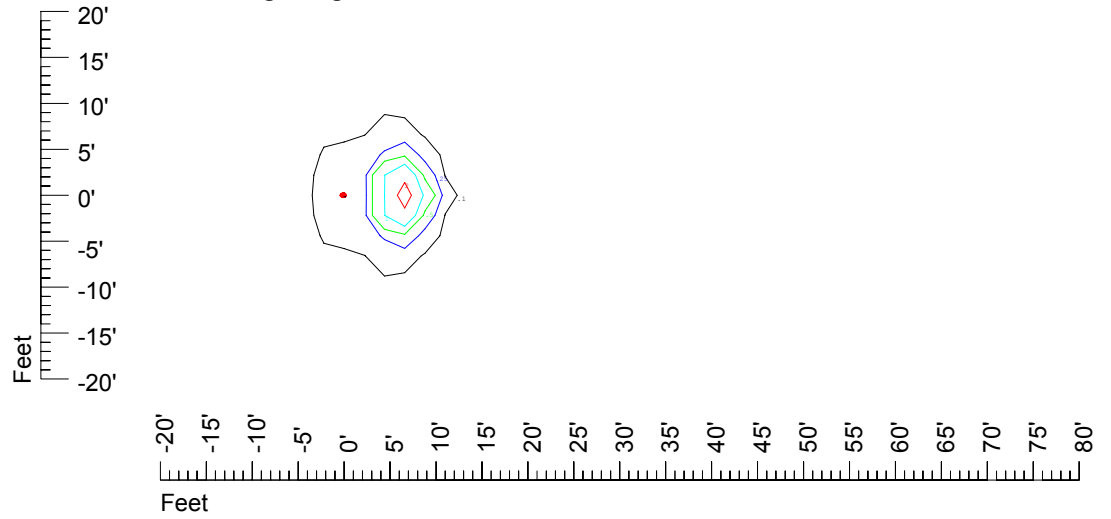

Mounting height 11' Tilt 15°

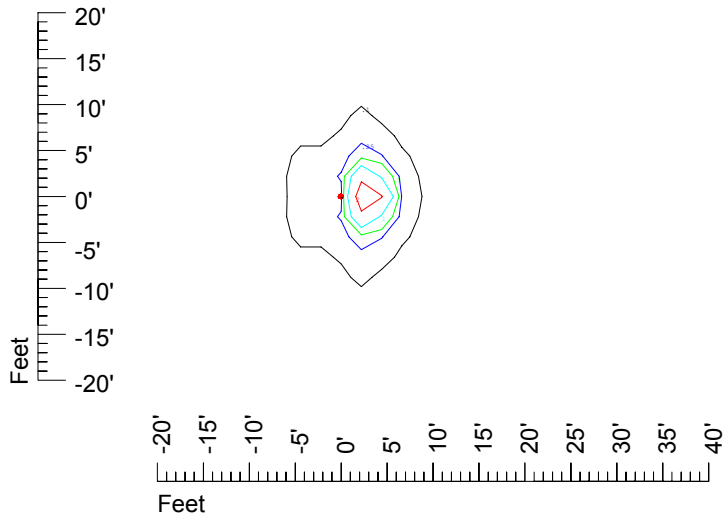

Mounting height 11' Tilt 45°

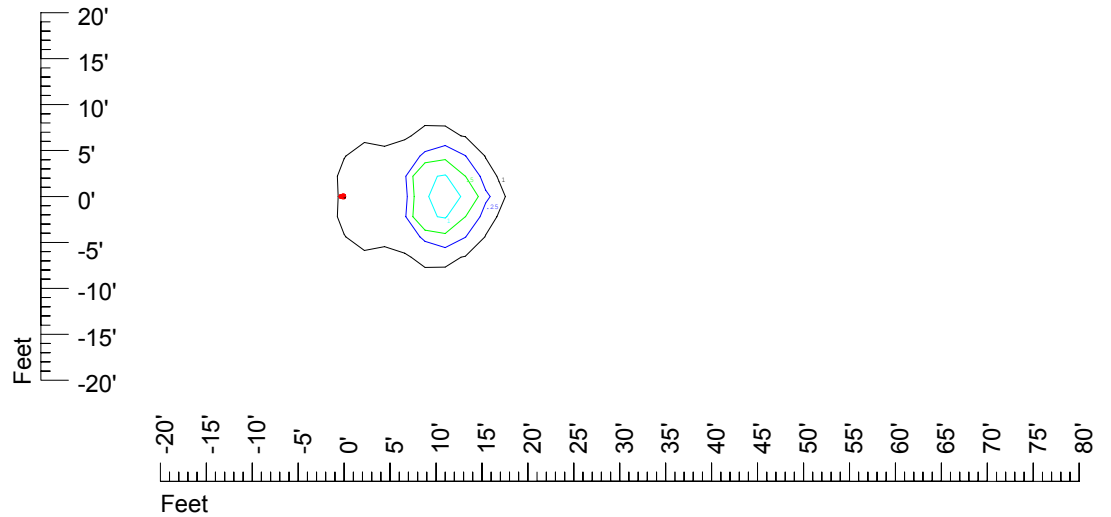

IES Photometric files C9277

Isoline template at 15' mounting height

Isoline values — 0.1 fc — 0.25 fc — 0.5 fc — 1.0 fc — 2.0 fc

Mounting height 15' Tilt 0°

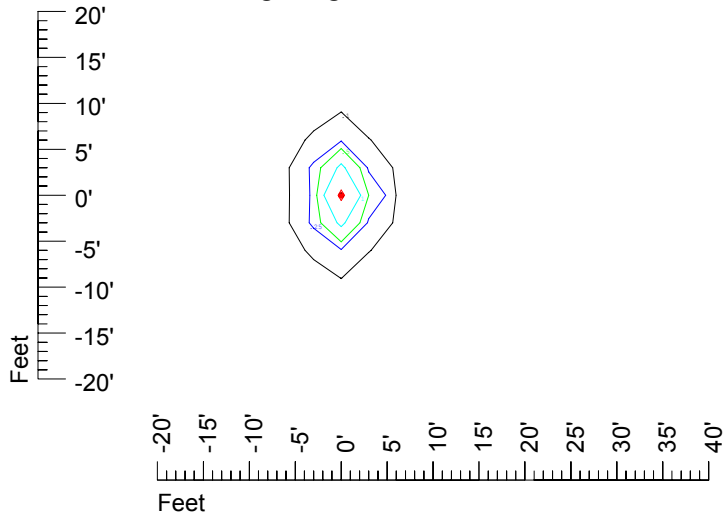

Mounting height 15' Tilt 30°

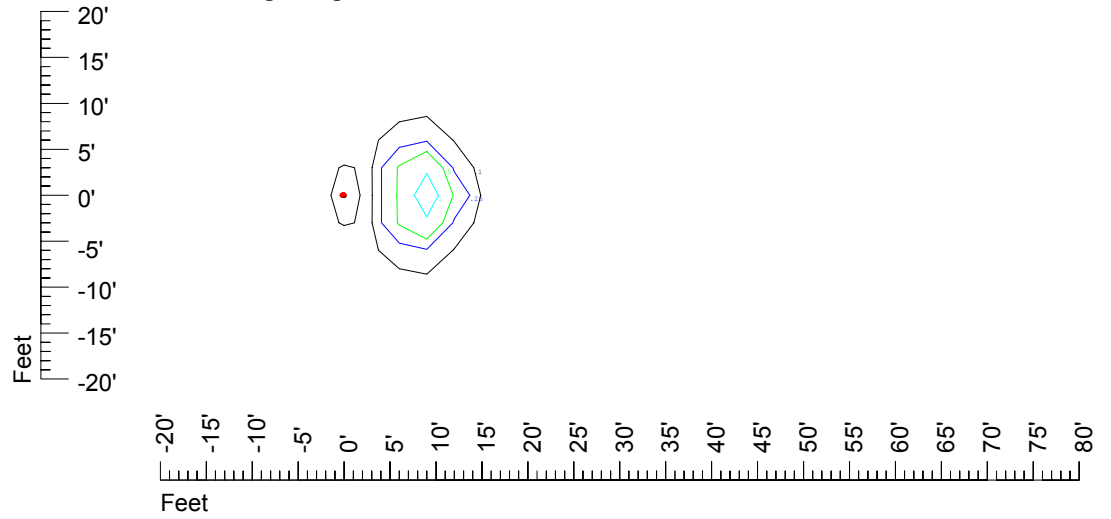

Mounting height 15' Tilt 15°

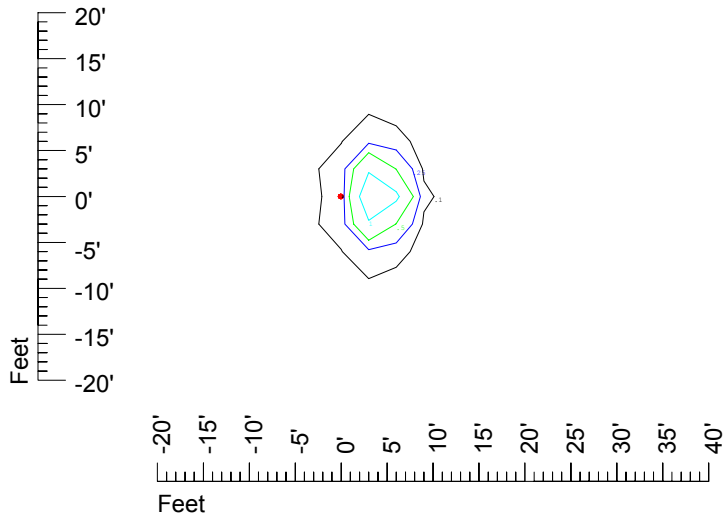

Mounting height 15' Tilt 45°

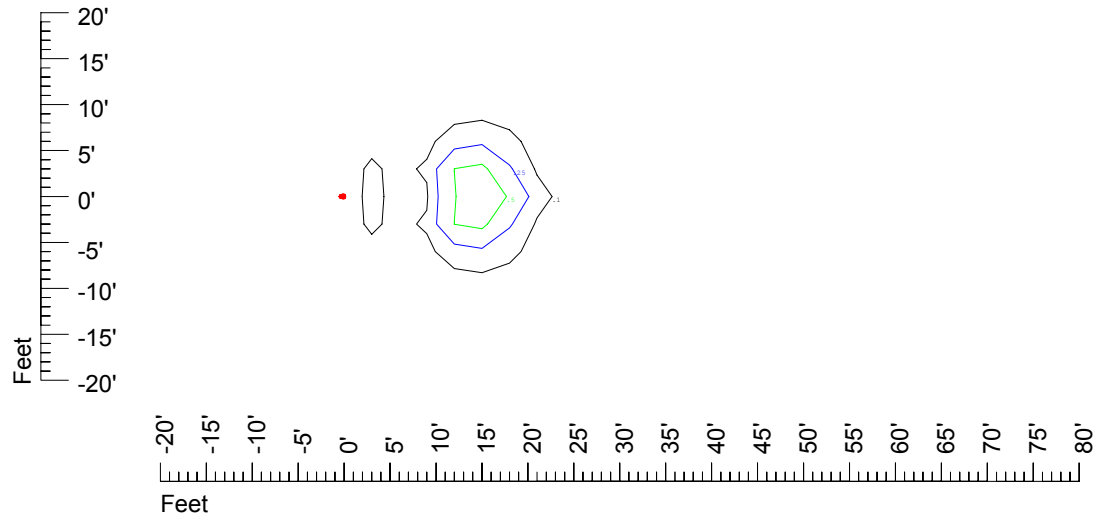

IES Photometric files C9277

Isoline template at 20' mounting height

Isoline values — 0.1 fc — 0.25 fc — 0.5 fc — 1.0 fc — 2.0 fc

Mounting height 20' Tilt 0°

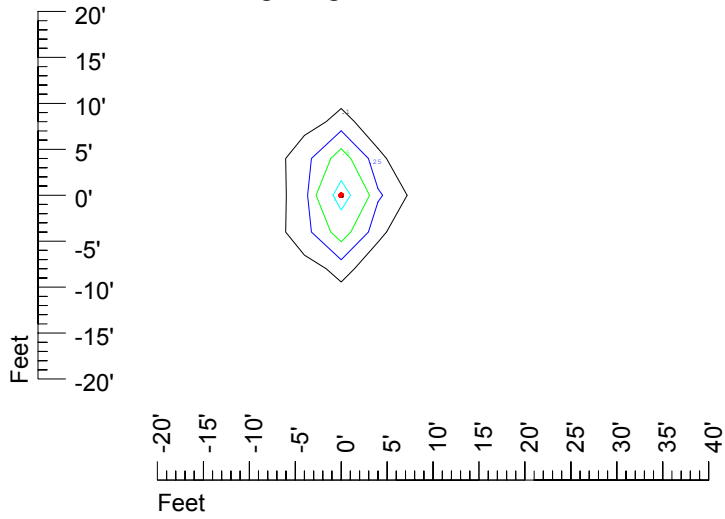

Mounting height 20' Tilt 30°

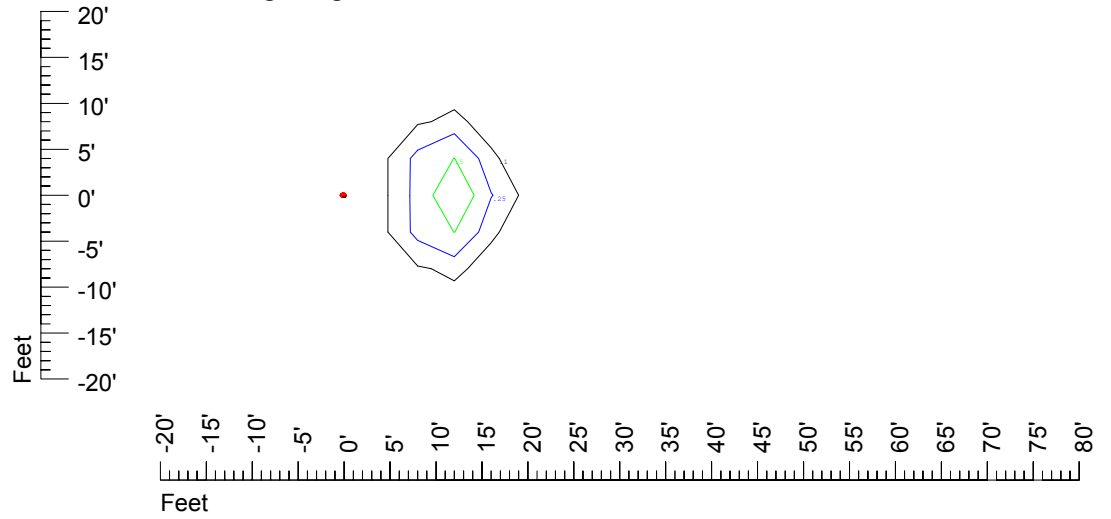

Mounting height 20' Tilt 15°

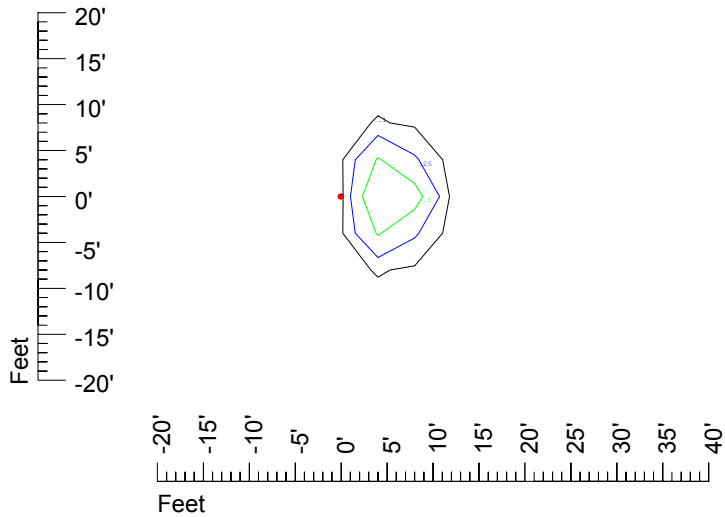

Mounting height 20' Tilt 45°

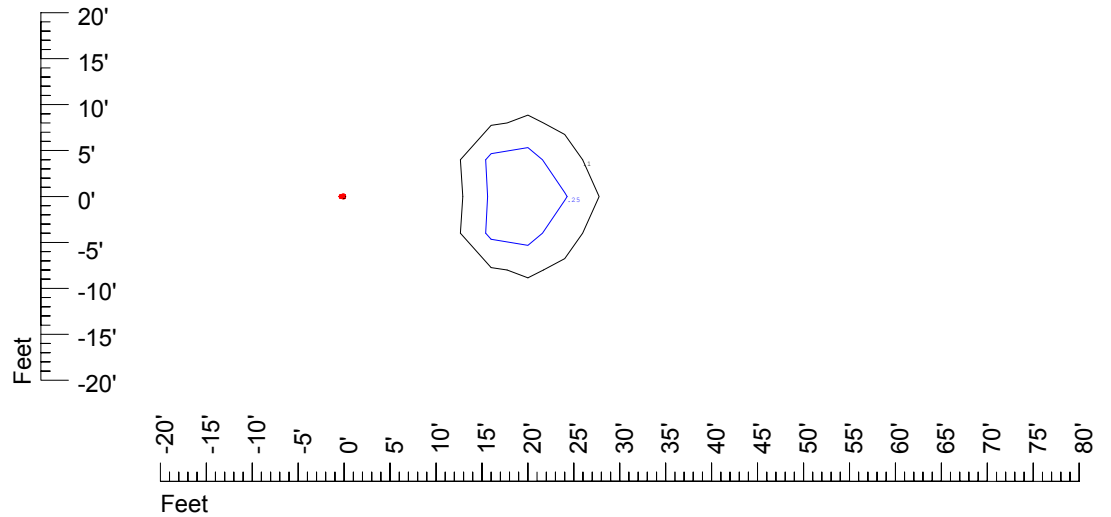

IES Photometric files C9277

Isoline template at 25' mounting height

Isoline values — 0.1 fc — 0.25 fc — 0.5 fc — 1.0 fc — 2.0 fc

Mounting height 25' Tilt 0°

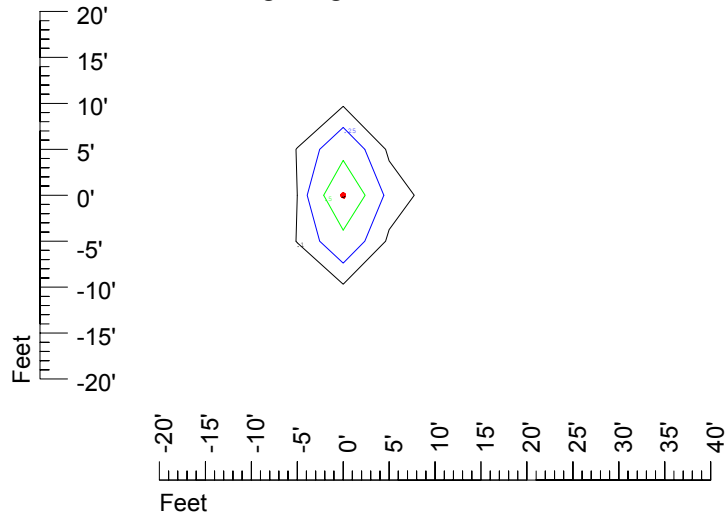

Mounting height 25' Tilt 30°

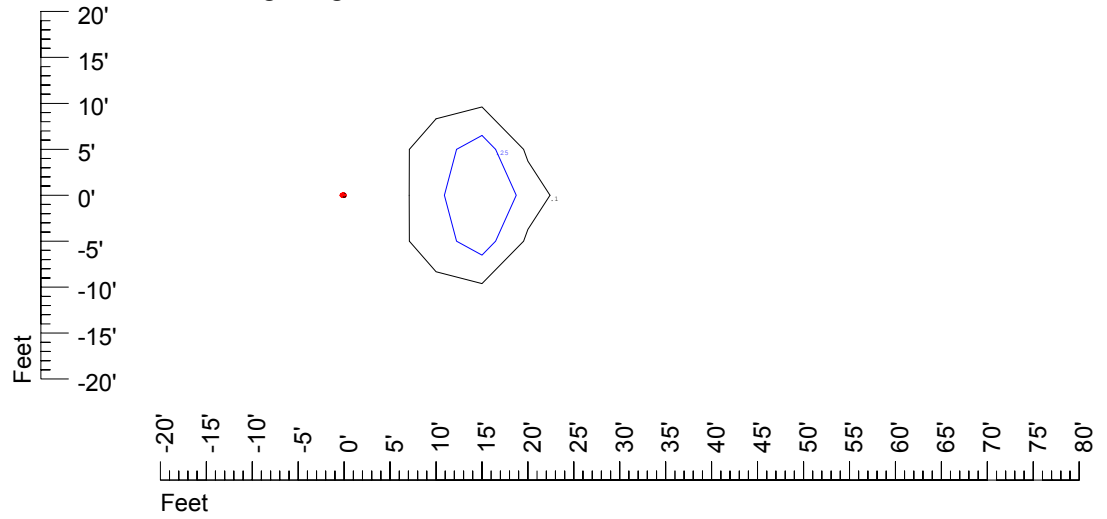

Mounting height 25' Tilt 15°

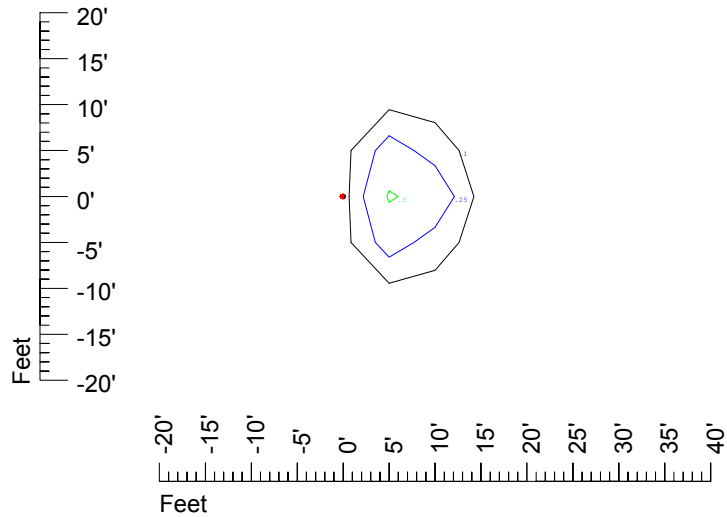

Mounting height 25' Tilt 45°

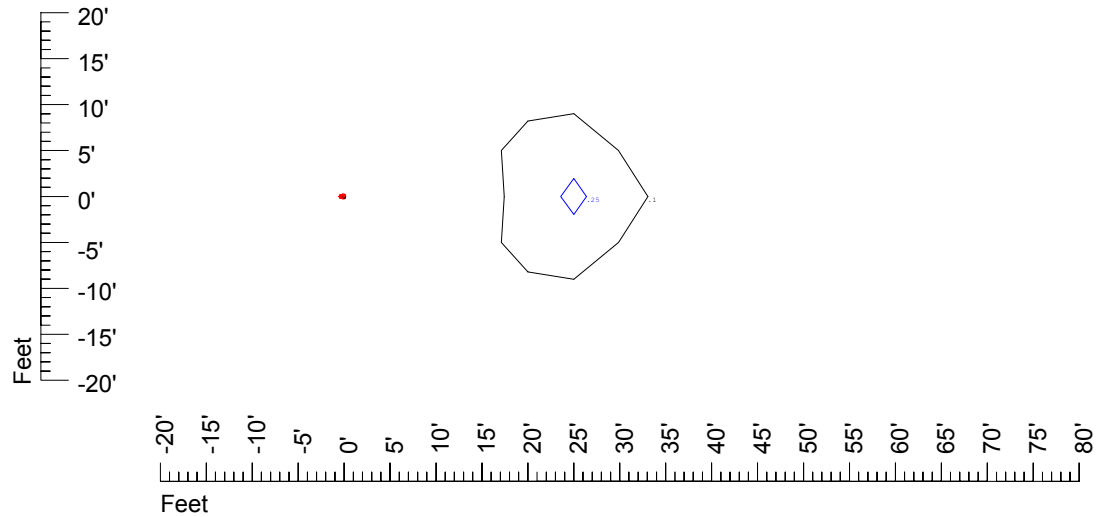

IES Photometric files C9277

Isoline template at 30' mounting height

Isoline values — 0.1 fc — 0.25 fc — 0.5 fc — 1.0 fc — 2.0 fc

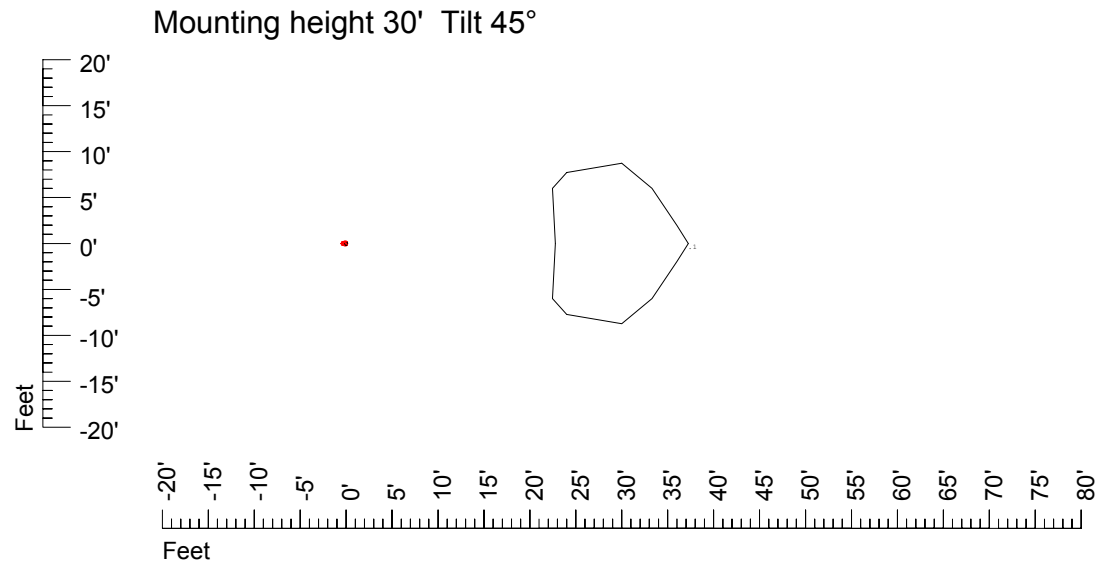
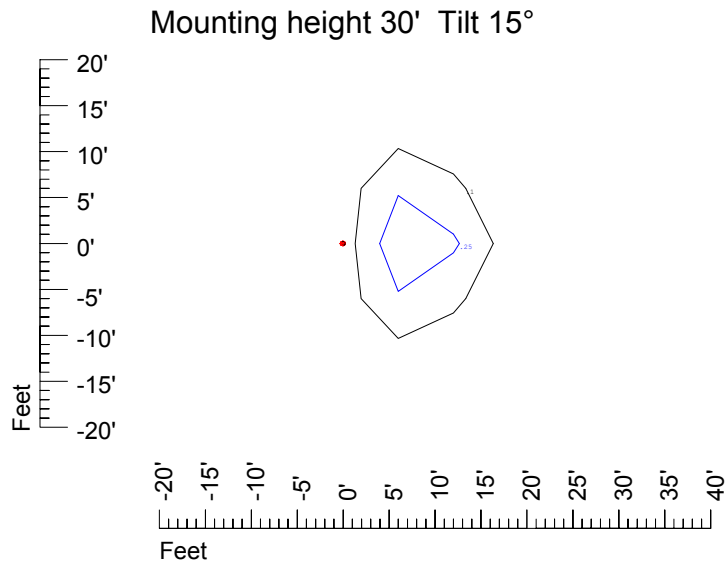
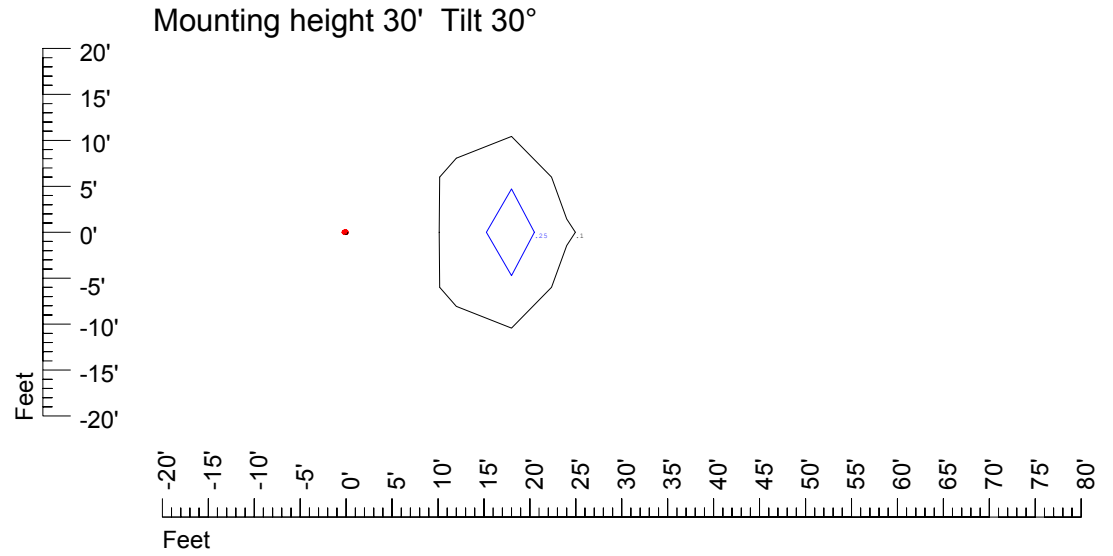
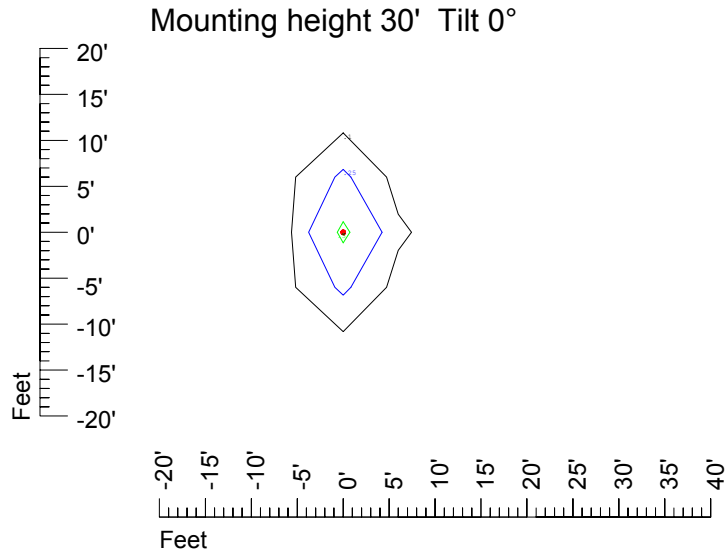

IES File: C9277

Lighting level in fc / Distance in feet

Vertical plan 0° to 180°
Horizontal plan 0°

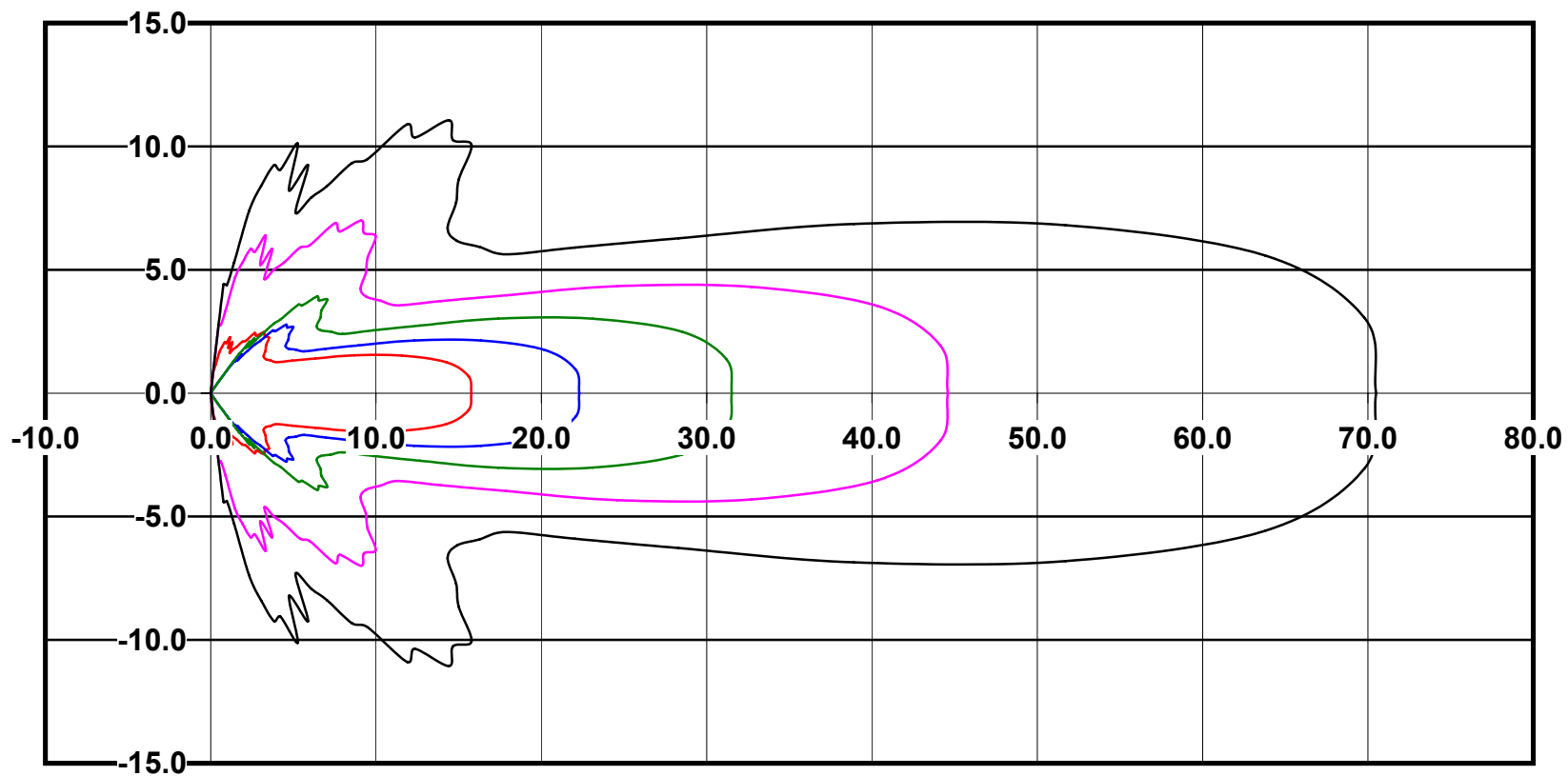

— 2 fc — 1 fc — 0.5 fc — 0.25 fc — 0.1 fc